



MIDI / DCB MULTI TRACK

DIGITAL KEYBOARD RECORDER

MSQ-700

Owner's Manual

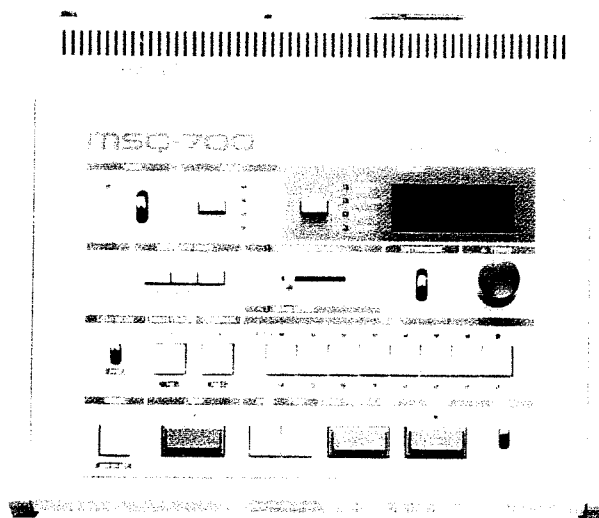

Warning – This equipment has been verified to comply with the limits for a Class B computing device, pursuant to Subpart J, of Part 15, of FCC rules. Operation with non-certified or non-verified equipment is likely to result in interference to radio and TV reception.”

The equipment described in this manual generates and uses radio-frequency energy. If it is not installed and used properly, that is, in strict accordance with our instructions, it may cause interference with radio and television reception.

This equipment has been tested and found to comply with the limits for a Class B computing device in accordance with the specifications in Subpart J, of Part 15, of FCC Rules. These rules are designed to provide reasonable protection against such a interference in a residential installation.

However, there is no guarantee that the interference will not occur in a particular installation. If this equipment does cause interference to radio or television reception, which can be determined by turning the equipment on and off, the user is encouraged to try to correct the interference by the following measure:

- Disconnect other devices and their input/output cables one at a time. If the interference stops, it is caused by either the other device or its I/O cable.

These devices usually require Roland designated shielded I/O cables. For Roland devices, you can obtain the proper shielded cable from your dealer. For non Roland devices, contact the manufacturer or dealer for assistance.

If your equipment does cause interference to radio or television reception, you can try to correct the interference by using one or more of the following measures:

- Turn the TV or radio antenna until the interference stops.
- Move the equipment to one side or the other of the TV or radio.
- Move the equipment farther away from the TV or radio.
- Plug the equipment into an outlet that is on a different circuit than the TV or radio. (That is, make certain the equipment and the radio or television set are on circuits controlled by different circuit breakers or fuses.)
- Consider installing a rooftop television antenna with coaxial cable lead-in between the antenna and TV.

If necessary, you should consult your dealer or an experienced radio/television technician for additional suggestions. You may find helpful the following booklet prepared by the Federal Communications Commission:

“How to Identify and Resolve Radio—TV Interference Problems”

This booklet is available from the U.S. Government Printing Office, Washington, D.C., 20402, Stock No. 004-000-00345-4.

MIDI/DCB MULTI TRACK

DIGITAL KEYBOARD RECORDER

MSQ-700

The Roland MSQ-700 Digital Keyboard Recorder is a multi-track polyphonic sequencer specially designed for polyphonic keyboards featuring MIDI.

Features

- Featuring both DCB and MIDI interface Bus, it is made possible to use both DCB and MIDI Keyboards.
- Eight independent Tracks are provided, each retaining Patch Preset, Dynamics, Bender information, etc., as well as Keyboard information.
- The MSQ-700 has memory capacity of 6500 steps (in single notes) throughout 8 Tracks.
- Memory Back-up system is fully supported by lithium battery.
- Both Step Load and Real Time Load are possible.
- Continue Play and Load function makes it possible to stop data anywhere you like and then continue to play or load from there.
- Punch In Jack enables to switch the unit from playing mode into loading mode just by pressing the Pedal Switch (DP-2).
- Start/Stop Jack offers remote control option for Start/Stop function.
- Merge function serves like Mix Down. of any recording equipment.
- Time Correct function allows automatically correcting slight variation of your key touching manner.
- Chain function allows playing up to 78 Track data in any combination.
- Sync is possible by means of the Sync (DIN), Tape Sync or MIDI Clock.
- Tape Interface function is included for saving the data in the MSQ-700 onto an ordinary audio tape.
- The interface system of the MSQ-700 allows saving or loading the data of a Track or Tracks you select.

Important

Please be sure that the Protect Switch on the back panel is set to OFF before turning the MSQ-700 on for the first time. On turning it on, the Display Window will show flashing **L. bat** several times then **Clr**. This indicates that the MSQ-700 is being now initialized (= all data is swept out of the MSQ-700's memory). If the Protect Switch has been set to ON, the Display will show **Prot** instead, and initialization is not executed.

When you turn on the MSQ-700 after loading any data, naturally the Protect Switch should be set to ON so that your data will be securely protected from unnecessary loss. But with this switch set to ON, if there is any error in the data you have loaded, the Display will respond as follows.

The Display Window shows flashing **L. bat several times then **Prot**.**

* In this case, entire data is broken, so simply set the Protect Switch to OFF then turn the unit on, and initialization will be automatically executed.

The Display shows **d. Err.**

- * In this case, pressing the Reset Key will normalize the MSQ-700 superficially (= all the relevant indicators light up), but internally, the data is damaged. So unless you crave for listening to the existing data, initialize the MSQ-700 immediately as explained below. If you fail to do so, you are annoyed by this error indication every time you turn on the unit.
- * Error is often caused by idiotic operation such as turning the unit off during loading or editing. Otherwise, the back-up battery is getting flat.

How to initialize

- ① Turn the MSQ-700 off.
 - ② Set the Protect Switch to OFF.
 - ③ While holding the Erase Button (in the Edit/Tape Mode Section), switch the unit on.
- * Do not release the Erase Button until the Display responds with **Clr**.
 - * Initialization will erase all the existing data from the memory.

NOTE

To avoid loss of your indispensable data, we recommend to save each one of the data.

SUB Switches

These four tiny switches are located on the left of the back panel.

1 Back Up

Memory Back-up function is available by pushing this switch into upward position. This switch is initially set to downward position by manufacturer to avoid battery waste, so be sure to push it up before using the MSQ-700.

2 After Touch

With this switch pushed into upward position, the MSQ-700 can store even After Touch information sent from MIDI keyboard. This, however, costs vast amount of memory considerably reducing the capacity for total notes. For this reason, unless you want After Touch information, keep this switch to downward position.

3 Mix Out

Usually, if just one keyboard is set up with the MSQ-700, this switch is to be pushed down. And if you are using more than one keyboard, set this switch to on. That is, with this switch off, only sequencer data in the MSQ-700 is sent through the MIDI Out, and if it is pushed into upward position, both sequencer and keyboard data fed through the MIDI Input is sent out.

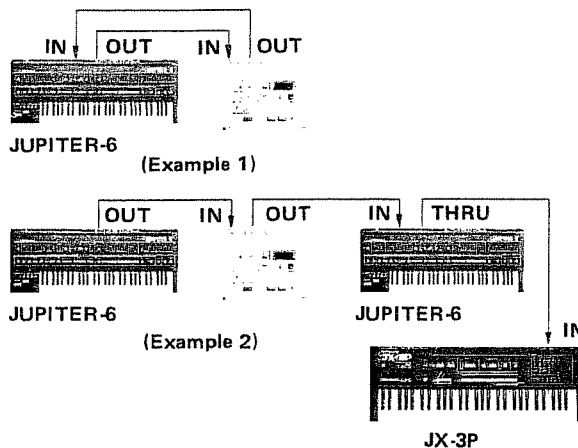

4 Tape

Usually, this switch is to be pushed into downward position, but the upward position may be better for tape saving or loading with high quality recording equipment rather than cassette tape recorder. Decide which position is more suitable for your case by the Level Test function. This switch, however, has no effect on the Tape Sync at all.

■ **Power**

- Before setting up the MSQ-700 with an external synthesizer, be sure to turn both of them off.

■ **Memory back-up**

The MSQ-700's memory back-up circuit is fully supported by lithium battery. The battery lasts more than five years, but contact your local Roland dealer and have it replaced within five years just in case.

■ **Location**

- Using the MSQ-700 near a neon or fluorescent lamp may cause noise interference. If so, change the angle or position of the MSQ-700.
- Avoid using the MSQ-700 in extreme heat or humidity or where it may be affected by dust.

■ **Cleaning**

- Use a soft cloth and clean only with a mild detergent.
- Do not use solvents such as paint thinner.

Content

Features	P 3	Continue Load	P 20
Important Notes		Overdub	P 21
SUB Switches	P 4	Tape Interface	
Power Supply	P 5	Level Test	P 23
Memory back up	P 5	Save	
Location	P 5	● Saving the Entire Data	P 24
Cleaning	P 5	● Saving the Selected Track or Tracks	P 24
Panel Descriptions		Verify	
Front Panel	P 6	● Verifying the Entire Data	P 25
Rear Panel	P 8	● Verifying the Selected Track or Tracks	P 26
Connection	P 9	Load	
Load		● Load	P 27
Real Time Load	P 10	● Loading into Empty Tracks	P 27
● Free Load	P 10	Sync	P 29
● Load with Bar Lines	P 11	Other Useful Functions	
Step Load	P 12	Available Note	P 30
Play		Changing MIDI Channels	P 30
Play	P 15	Specifications	P 31
Continue Play	P 15		
Multi Track Play	P 16		
Chain Play	P 16		
Edit			
Erase	P 18		
Merge	P 18		
Time Correct	P 19		

Panel Description (Front Panel)

Memory Protect Indicator

This lights when the Memory Protect Switch on the rear panel is set to ON.

Mode Switch

This includes three positions: Chain, Normal and Tape. The Chain mode allows programming and playing Chain Tracks. In the Normal mode, you may load, play or edit data. Finally, the Tape position is for saving, verifying or loading the data onto a tape or from the tape.

Edit/Tape Mode Keys

Each of these three keys has double functions. In Edit mode, they have Erase, Merge and Time Correct functions. In Tape mode, they serve as Save, Verify and Load Keys.

Clock Source Selector Key

This is used to select one of the four options of Clock signals.

Clock Source Indicators

These indicators are provided to tell you which Clock signal is currently selected.

INT The external device(s) is synchronized with internal Clock and the tempo can be controlled with the MSQ-700's Tempo Knob.

TAPE . . . The MSQ-700 is synchronized with the unit connected to the Tape Sync Jack.

MIDI . . . The MSQ-700 is synchronized with the unit connected to the MIDI Jack.

* If loading or playing in the Clock mode other than INT, and the external clock signal stops coming, press the Reset Key and the MSQ-700 will stop. Do not press the Stop/Continue Key, as this does not stop the unit.

Display Window

Display Selector Key

This key is used to select different items to be shown in the Display.

Display Function Indicators

Measure/Chain . . . When this indicator lights, measure number, or Track Program number and its Track number are shown in the Display depending on the mode.

Available Note . . . When this lights, the Display shows how many more notes can be loaded.

Tempo When this lights, the Display shows the tempo of clock signal currently selected.

Status The Display shows **DCB** when the DCB function is selected. When MIDI function is selected, the Channel Number that the MSQ-700 accepts will be shown. **ALL** is shown when the MSQ-700 is ready to accept all-channel data.

Beat Per Measure Indicator

This indicator lights to show that you may select the Beat Per Measure.

Resolution Indicator

This indicator lights to show that you can now select a Resolution you like.

Beat Per Measure/Resolution Switch

This switch is used to set Beat Per Measure or Resolution.

Metronome Switch

OFF No metronome sound is heard at all.
Load/Play . . . Metronome will sound in loading or playing mode.

ON Metronome will be heard in any mode, as long as clock signal is being sent to the MSQ-700.

Tempo Indicator

This flashes in the tempo of the clock signal.

Tempo Knob

This is to change the tempo of the internal clock.

Load Mode Switch

This selects either of Real Time or Step Load mode.

Multi Track Key with Indicator

Use this Key to select more than one Track simultaneously.

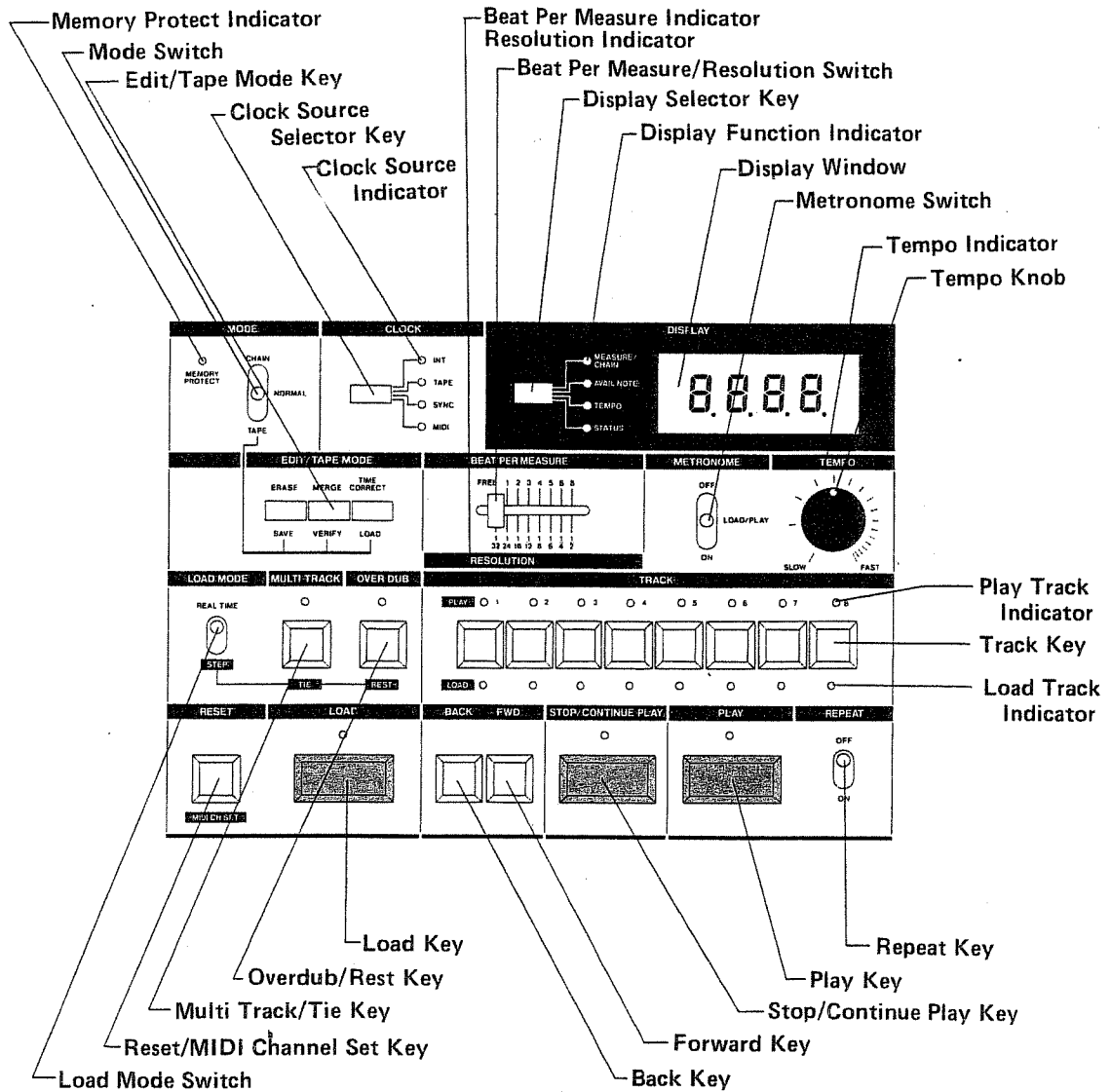

Overdub/Rest Key with Indicator

Depress this key to load by real time playing to the existing data.

Play Track Indicator (green)

Load Track Indicator (red)

Track Keys

These Track keys can be used to select a Track or Tracks to be played or loaded. Also, these work as number keys to set File Numbers. The green Play Track Indicator lights to show playing the corresponding Track is possible. The red Load Track Indicator lights to show the corresponding Track can be now loaded.

Reset Key

Pressing the Reset Key will cancel the current mode or reset the data. Also, this key is used to change the MIDI Channels.

Load Key with Indicator

This is pressed to start loading data.

* When the Protect Switch on the rear panel is set to ON, the Display shows **Prot** for a while and the Load Key does not work.

Back Key

Forward Key

Stop/Continue Play Key with Indicator

This key is pressed to stop playing or loading, Pressing the key again will continue playing the data from the measure shown in the Display.

Play Key with Indicator

Pressing this key will always start playing the data from the beginning.

Repeat Switch

With this switch set to ON, the data will play repeatedly.

Panel Description (Rear Panel)

Power Switch

Tape Sync In/Out Jacks

When the Mode Switch is set to the Tape position, these jacks are used to save (or load) the data in the MSQ-700 onto a tape (or from the tape). When the Mode Switch is set to the Normal or Chain position, these jacks can be connected to a multi track recorder for tempo sync.

Protect Switch

With this switch set to ON, the data in the MSQ-700's memory will not be replaced with any other data, therefore protected.

MIDI In/Out Jacks

A MIDI keyboard such as JX-3P or JP-6 can be connected to these jacks.

Bus Selector Switch

By using this switch, either of the DCB or MIDI device can be selected to connect to the MSQ-700.

Sync In/Out Jacks

The devices featuring the Sync Jack (DIN) such as TR-606, TB-303 or TR-909 can be connected to the MSQ-700, therefore synchronized.

Punch In Jack

Just by pressing the Pedal Switch DP-2 connected to this jack, you can turn the MSQ-700 from the Play mode into the Load mode.

Start/Stop Jack

If you want remote control for Start/Stop function, connect the DP-2 to this jack.

When the MSQ-700 is not running, pressing the Pedal will start playing the data from the beginning. When the MSQ-700 is playing or loading, pressing the Pedal will stop it. When the MSQ-700 is in Stand-by mode for loading (the Display shows `rdy`), pressing the Pedal will start loading. This is useful for such a music starting with a rest.

SUB Switches (Refer to P. 4)

DCB Connector

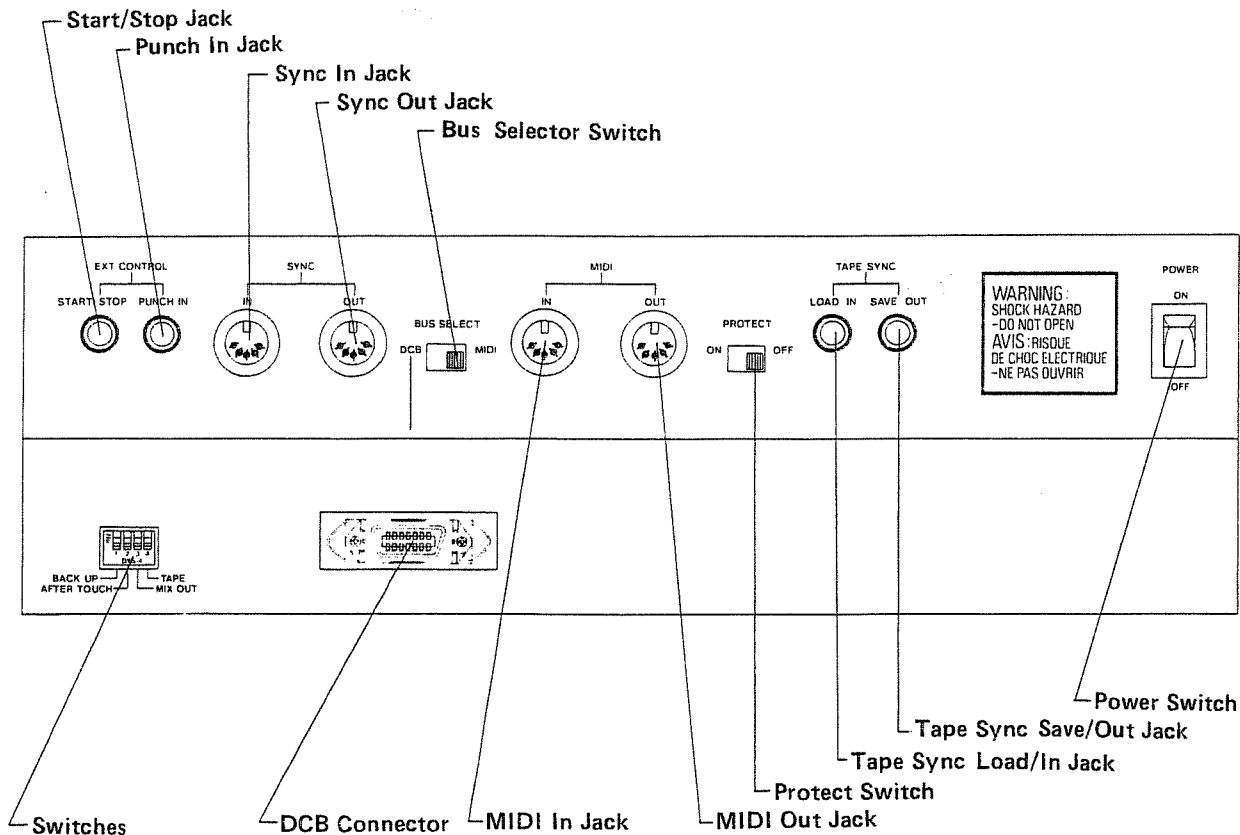

Connection

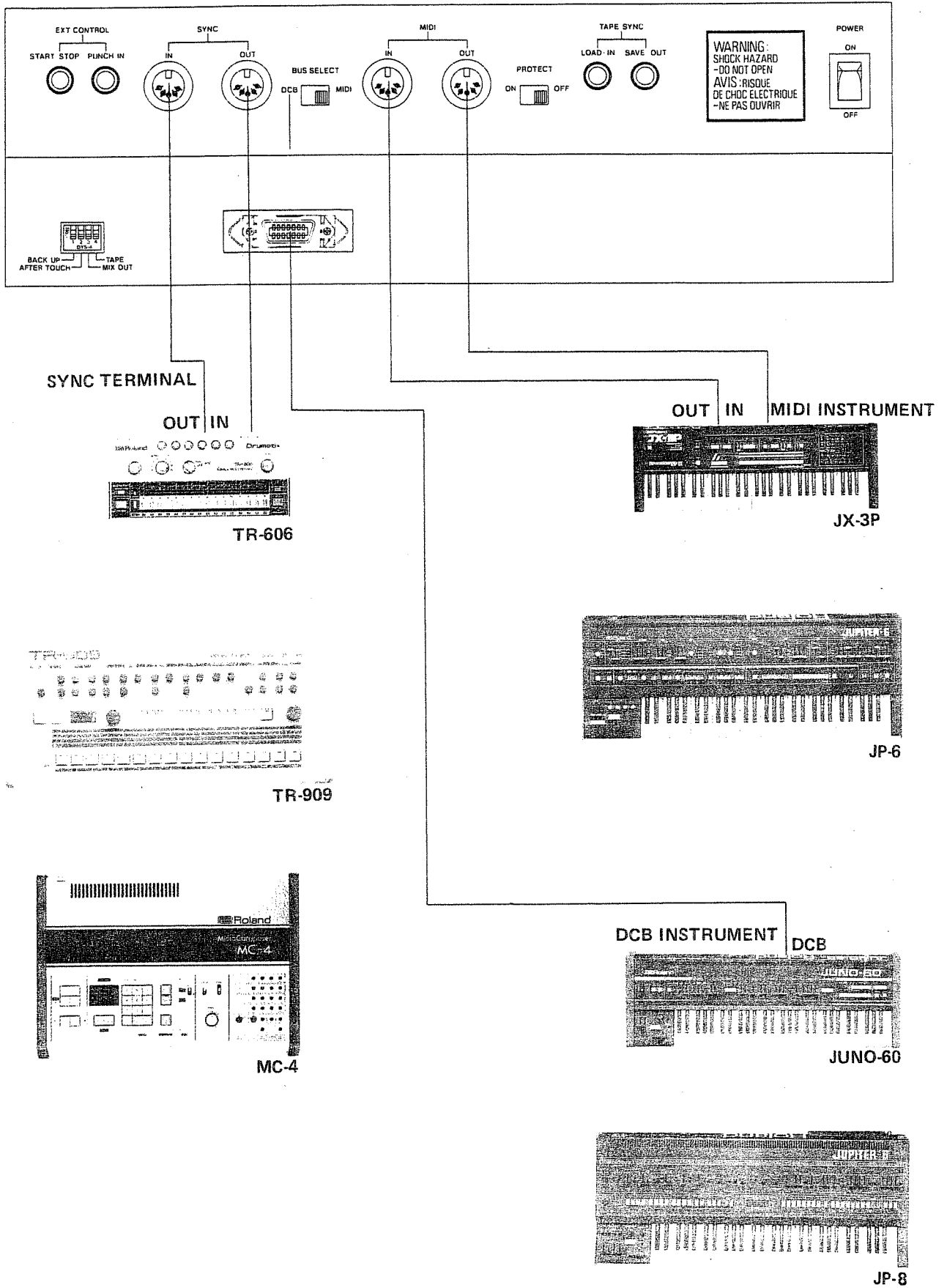

Load

Real Time Load

When the Mode Switch is set to NORMAL and the Load Mode Switch to REAL TIME, the MSQ-700 is in the Real Time Load mode, therefore what you play on the keyboard will be faithfully loaded into the sequencer. Moreover, you can select any of 7 options of the Beat Per Measure positions or even Free Load (= no bar lines).

► Operation

● Free Load

Set the Mode Switch to the Normal position and the Load Mode Switch to Real Time.

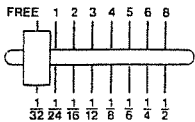

① Make sure that your synthesizer generates desirable sound.

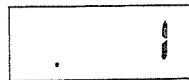

② Make sure that the Beat Per Measure Indicator lights, then set the Beat Per Measure Switch to the FREE position.

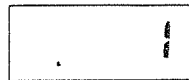

③ Press any Track Key you like.

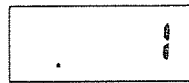

The red Indicator under the selected key will light up. If the green Indicator above the key lights up as well, that Track has been already loaded. So, if you do not want lose that data, choose other empty Track.



④ Press the Reset Key.

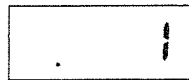

⑤ Press the Load Key.

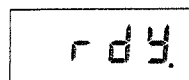

The Load Indicator starts blinking.

⑥ Now, playing the keyboard will automatically start loading.

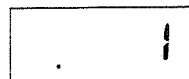

The Load Indicator stops blinking and remains lighted. Here, the measure number in the Display Window does not represent accurate measure, but can be used like a Tape Counter.



⑦ To stop loading, press the Stop Key.

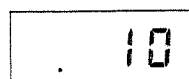

The Stop Indicator lights up and the Load Indicator goes out.

(Loaded up to 10)

● **Lead With Bar Lines**

Set the Mode Switch to the Normal position and the Load Mode Switch to Real Time.

- ① Make sure that your synthesizer generates desirable sound.

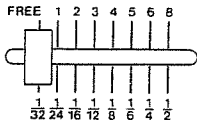

- ② Be sure that the Beat Per Measure Indicator lights, then set the Beat Per Measure Switch to the 1, 2, 3, 4, 5, 6 or 8 position, depending on the music you are to load.

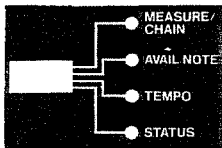
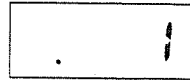

- * If you wish to see the number of the measure currently playing, set the Display mode, to Measure/Chain by using the Display Switch on the left of the Display.



- * If you need metronome sound to play to, set the Metronome Switch to Load/Play.



- ③ Press any Track Key you like.

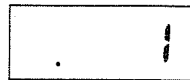

- ④ Press the Reset Key.

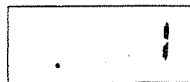

- ⑤ Press the Load Key.



(4 beat)



- ⑥ When you have reached the last measure of the music, press the Stop Key.

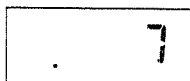

(Loaded up to 6)

The red Indicator under the selected key will light up. If the green Indicator above the key light up, that Track has been already loaded. So, if you do not want to lose that data, choose other empty Track.

- * When the INT is selected in the Clock Source Section, actual loading will start from the 3rd measure. If other than INT is selected (= external signal controls the MSQ-700), the Display initially shows `rdy` and loading will start the moment the external device starts running or the DP-2 connected to the Start/Stop Jack is pressed. When loading starts, the Load Indicator stops blinking and remains lighted.

The Stop Indicator will start flashing. Loading will automatically stop in the end of the measure and the Stop Indicator stops flashing and remains lighted.

Note

- If the Protect Switch on the rear panel is set to ON, pressing the Load Key will cause the Display Window to show "Prot" for about a second.
- If all the memory capacity is used up, the Display shows "FULL" and the MSQ-700 automatically stops loading. If this happens, the data may not be played properly.

Step Load

In this mode, only pitches can be loaded step by step. The timing values are the same (= the shortest timing value set with the Resolution Switch) throughout the whole music unless you purposely change it by using the Tie or Rest Keys.

► Operation

- ① Find out the shortest note in the music piece you are to load. Then represent the entire score with the shortest timing value.



- ② Be sure that the MSQ-700 is not running.



- ③ Set the Load Mode Switch to the position.

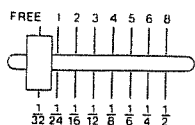

- ④ Make sure that the Beat Per Measure Indicator lights, and set the Beat Per Measure Switch to an appropriate position according to the music you are to load. If none of the 7 options (1, 2, 3, 4, 5, 6 and 8) applies to the music you are to load, set it to the Free position.



- ⑤ Set the Load Mode Switch to STEP.

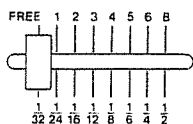

- ⑥ Make sure that the Resolution Indicator lights and select the appropriate Resolution according to the shortest timing value in your music.



- ⑦ Press any Track Key you like.



- ⑧ Press the Load Key.



- ⑨ If loading has been completed, press the Stop Key.

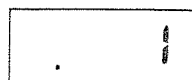

The Stop Indicator lights up.

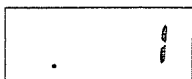
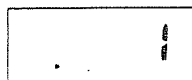
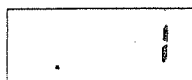
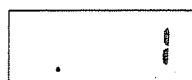
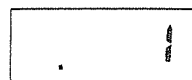

The red Indicator under it will light up. Here, if the green indicator above the key lights up as well, data is previously loaded in that Track. So, if you do not want to erase the existing data, select other empty Track.

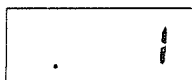



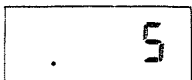

The Indicator starts flashing. The MSQ-700 is now in the Load mode, so you can start loading at any time.







- * Each time a chord, a single note or rest is loaded, one step (=shortest timing set with the Resolution Switch) is advanced.
- * How you play the keyboard does not affect the timing value of each note; all the notes will be loaded in the same length. Please note that the pitches are loaded the moment the keys are released.

In the DCB mode, if you wish to load a chord which cannot be pressed at the same time, turn on the Hold function of the keyboard and play each key one after another, then turn off the Hold.

Example: If loading  (in Step Load mode )

Correct: Press  → Release all the keys → Press  → Release all the keys.

Wrong: Press  with  being held down → Release all the keys.











( will be loaded instead of )

■ Step Value

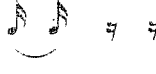
If the shortest timing value is 16th note, quarter note and eighth note can be replaced as shown below.

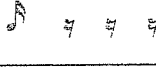
The shortest timing value is counted one step, so if 16th note = 1 step, eighth note = 2 steps and quarter note = 4 steps.

In this way, about 6500 steps notes (in single note) can be loaded into the MSQ-700. (Even if you load a quarter note with four of sixteenth notes, only one step of memory is used.)

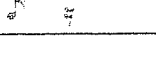
Note

- If the Protect Switch on the rear panel is set to ON, pressing the Load Key will cause the Display Window to show **Prot** for about a second.
- If all the memory capacity is used up, the Display shows **FULL** and the MSQ-700 automatically stops loading. If this happens, the data may not be played properly.

< Example Loading >

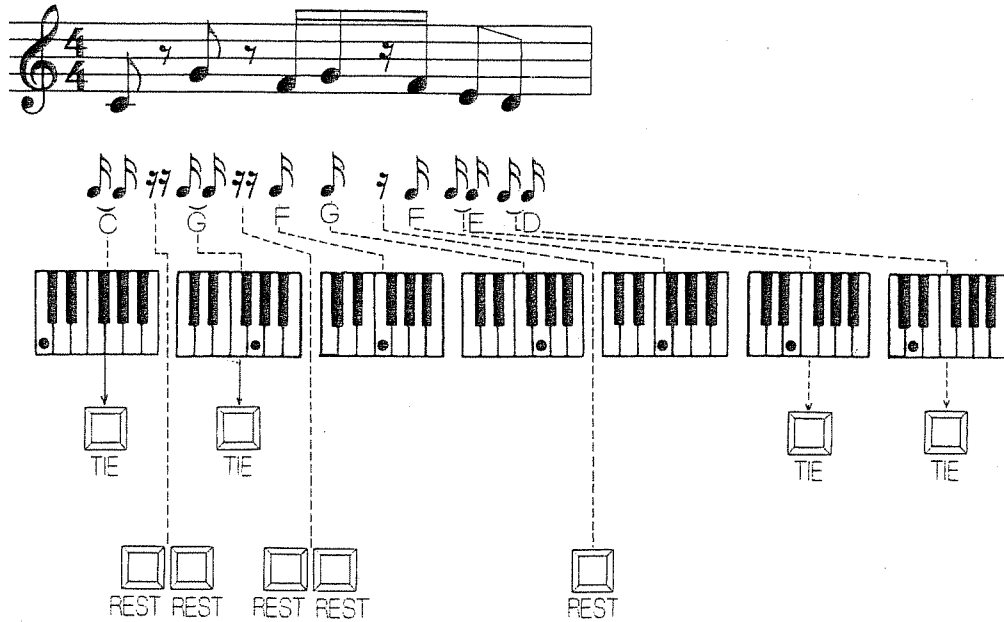

- | | | | |
|---|-----|------------------------------|-----|
| 1) Set the Resolution Switch to 1/16. | | 11) Press the Rest Key once. | + 1 |
| 2) Select a Track, and press the Reset Key then the Load Key. | | 12) Play the fifth note F. | + 1 |
| 3) Play the first note C. | + 1 | 13) Play the sixth note E. | + 1 |
| 4) Press the Tie Key once. | + 1 | 14) Press the Tie Key once. | + 1 |
| 5) Press the Rest Key twice. | + 2 | 15) Play the seventh note D. | + 1 |
| 6) Play the second note G. | + 1 | 16) Press the Tie Key once. | + 1 |
| 7) Press the Tie Key once. | + 1 | | |
| 8) Press the Rest Key twice. | + 2 | | |
| 9) Play the third note F. | + 1 | | |
| 10) Play the fourth note G. | + 1 | | |
- The number on the far right shows the number of steps that each procedure costs. The total number is 16, that is 16 of sixteenth notes (1/16 note x 16).

Play

Play

► Operation



① Make sure that the MSQ-700 is not running.

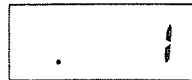

The Stop Indicator lights.



* Here, if you need metronome sound, set the Metronome Switch to Load/Play position.



② Press the Track Key which you wish to play. If the green Indicator above the key does not light up, no data is loaded there.



The green indicator above the key lights up.



③ Press the Play Key.



The Play Indicator lights up.

The data loaded in the Track will start playing.

* If you wish to play the same Track repeatedly, set the Repeat Switch to ON.

* You can change the playing tempo with the Tempo Knob. (When external clock is controlling the MSQ-700, the Tempo Knob on the external device decides the tempo.)

Continue Play

It is possible to stop playing and continue playing from there. Also, you can forward or back up the data and continue to play from there.

► Operation



① Press the Stop/Continue Key.

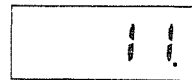

The Stop Indicator lights up.

(Played up to 11)



② Press the Stop/Continue Key.



The Play Indicator lights up.









The MSQ-700 starts playing the same Track from the next measure.

Multi Track Play

More than one Track can be simultaneously played.

* When the Multi Track Key is depressed, the Track Keys are alternately turned on and off by pressing. (When the Multi Track Key is not used, only one Track Key lights up, that is, pressing another Track Key will cancel the one currently selected.)

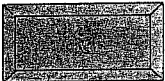









► Operation

	① Make sure that the MSQ-700 is not running.		The Stop Indicator is lighted.
	② Press the Multi Track Key on.		The Indicator will light up.
	③ Select the Tracks to be played by pressing the corresponding Track Keys one after another.		The green indicator above the Key will light up.
	④ Press the Play Key. All the selected Track will start playing.		The Play Indicator lights up.

Chain Play

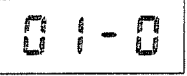
It is also possible to program up to 78 Tracks in any combination you like.

► Operation

	① Make sure that the MSQ-700 is not running.		The Stop Indicator lights.
	② Set the Mode Switch to the Chain position.		
	③ Press the Reset Key.		
	④ Press the Load Key.		The Load Indicator lights up.
	⑤ Press the Track Keys which you wish to play in such a order one after another.		The Stop Indicator will light up.
	⑥ Press the Stop Key.		

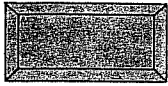

- ⑦ Press the Play Key.
The MSQ-700 will play Tracks in the combination you have set.

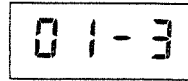

The Play Indicator will light up.

-
- * When you are programming Chain Tracks, the Display shows the current Program number on the left and the Track number being programmed on the right. That is, while holding the Track Key down, the corresponding Track is shown in the Display. Releasing the Track Key here will forward one Program number, and if the right of the Display shows " 0 ", no Track is yet programmed there.
- * If you have set the Repeat Switch to ON, this set of the Track will play repeatedly.

● Cancelling Chain Tracks.



- ① Press the Reset Key.



- ② Press the Load Key.

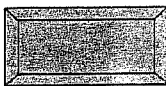

- ③ Press the Stop Key.

Note on Forward & Back Keys

- * The action of the MSQ-700 will become more and more sluggish as the data is being loaded. When going to the beginning of a music by using the Forward or Back Key, you may notice that it takes a few seconds. (During this, the Stop Indicator stays dark.)
- * If a Track includes two kinds of beats (e.g. the first half is 4 beat, and the later half is waltz), and if you are forwarding or backing the data through the two parts, the measure number in the Display does not show the actual measure currently being played.

Edit

Erase

► Operation



- ① Press the Track Key which contains the data you wish to erase.

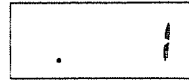

The green indicator above the key will light up, but if there is no data loaded there, the indicator remains dark.



- * If you wish to erase more than one Track data, initially depressed the Multi Track Key, then press the relevant Track Keys.

ERASE



- ② Press the Erase Key in the Edit/Tape Mode Section.



The green indicator(s) above the selected Track(s) will start blinking.

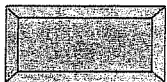

- ③ Press the Load Key. In a few seconds, erasing will be completed.



The Load Indicator will light up.

Merge

It is possible to mix up to 7 Track data and load into another Track.

► Operation



- ① Make sure that the Multi Track Indicator lights.

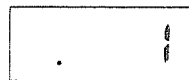

- ② Press the Track Keys that contain the data you wish to merge.

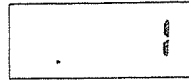

The green indicators above the selected Track will light up. (If there is no data loaded, the indicator does not light up.)

- * Here, if Beat Per Measure set in each Track data varies, the Track of the smallest number will have priority. That is, the Beat Per Measure set in that Track will control all the rest of the Tracks.

- * Also, if you select only one Track, Copy function is available instead of Merge, that is, the selected Track will be merely copied to other Track.

MERGE



- ③ Press the Merge Key in the Edit/Tape Mode Section.



The lighted green indicator(s) above the selected key(s) will start blinking.



- ④ Press the Track Key where you wish to load the merged data.



The red indicator starts blinking.

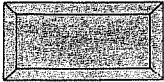

- ⑤ Press the Load Key. Merge is completed in a few seconds.

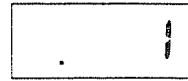

The Load Indicator lights up.

Time Correct

This function allows modification of slight variation of your key touch manner in real time loading and loading into another Track.

► Operation



- ① Press the Track Key which consists of the data requiring Time Correct. If there is no data in it, the indicator stays dark.

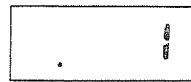

The green indicator above the selected Track will light up.

TIME CORRECT



- ② Press the Time Correct Key in the Edit/Tape Mode Section.

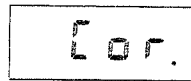

The green indicator above the key starts blinking.

- * It is not possible to choose more than one Track at the same time. Even if you try to select more than one key by using the Multi Track Key, only the Track of the smallest number is automatically selected.

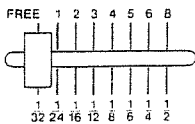

- ③ Make sure that the Resolution Indicator lights, then select the Resolution (= shortest timing value) you like.

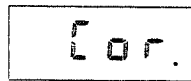

The green indicator above the key starts blinking.



- ④ Press the Track Key where you wish to load the modified (= Time Corrected) data.

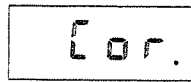

The red indicator under the key will start blinking now.



- ⑤ Press the Load Key. Loading is completed in a few seconds.

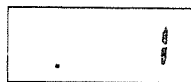

The Load Indicator lights up.

■ Time Correct

The MSQ-700's Time Correct function allows modification of slight variation of your key touch manner in real time loading. Therefore, your performance will be automatically made more accurate. For instance, even if you have failed to play a chord at precisely the same time, it can be later corrected and then loaded into another Track.

In Time Correct, usually smaller timing value than the Resolution you have set for the original data should be selected (if the Resolution has been set to 1/8, select 1/16 or 1/32), so that proper Time Correct effect is obtained. If setting longer or the same timing value, you may be annoyed by various troubles such as timing value(s) differs, a note(s) is lost, etc.

This Time Correct operation can be done as many times as you like, unless the original data is erased. So try finding the most appropriate Resolution.

Note

- If the Protect Switch on the rear panel is set to ON, pushing any key of the Erase, Merge or Time Correct on will cause the Display Window to show **Prot** (for about a second).
- In Merge or Time Correct mode, if all the memory capacity is used up, the Display shows **FULL** and the MSQ-700 automatically stops loading. If this happens, the data may not be played properly.

Continue Load

Continue Load is a useful function that allows loading continually after entire data is loaded or played up, or even after halfway of data playing or loading. Also, it is possible to forward or back up the data and continue to load from there.

► Operation



- ① Make sure that the MSQ-700 is stopped where you like.

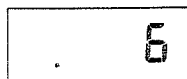

The Stop Indicator is lighted.



- ② Set the Load Mode Switch to the Real Time position.

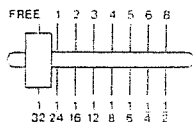
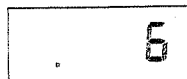

- ③ Be sure that the Beat Per Measure Indicator lights, then set the Beat Per Measure Switch to an appropriate position according to the music you are to load. (Usually, to the same position where you have set in your first loading.)

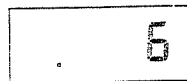

- ④ If you are to load in Step mode, set the Load Mode Switch to the Step position, and select the Resolution you like.

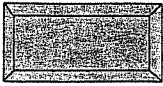

- ⑤ Press the Load Key.

Now, the MSQ-700 is turned to usual loading mode, so you can continue loading from here by proceeding normal loading procedure.



- * If the Multi Track Indicator lights, Continue Load is not possible.

Overdub

The MSQ-700 features Overdubbing function that allows you to overdub on the existing data in real time playing along with the data. When using the DCB, the existing data is loaded into a Track with the new data. If, however, using the MIDI, only new data is loaded into the Track, therefore, later merging will be necessary for actual overdubbing effect.

▶ Operation



- ① Press the Track Key that you wish to play.

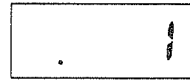

The corresponding Play Track Indicators light up.



- * To play more than one Track, initially depress the Multi Track Key, then press each Track Key one after another.



- ② Set the Load Mode Switch to the Real Time position.

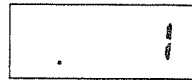

- ③ Push the Overdub Key.

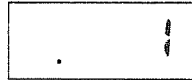

The Indicator will light up.

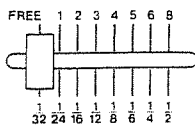

- ④ Make sure that the Beat Per Measure Indicator lights, then set the Beat Per Measure Switch to an appropriate position depending on the music you are to load. (Usually to the same as the Beat Per Measure set in the Track(s) you are to play.)

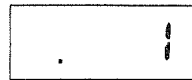

- ⑤ Press the Track Key where you wish to load the new data.

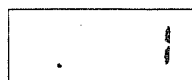

The red indicator under the key will light up.



- ⑥ Push the Load Key.
- * Two measures will pass without any loading.

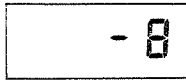

The Load Indicator lights up.

- ⑦ Now, start real time loading.

Tape Interface

The MSQ-700 features Tape Interface function that allows you to save the data in its memory onto an ordinary audio tape for storage and later retrieval.

► Connection

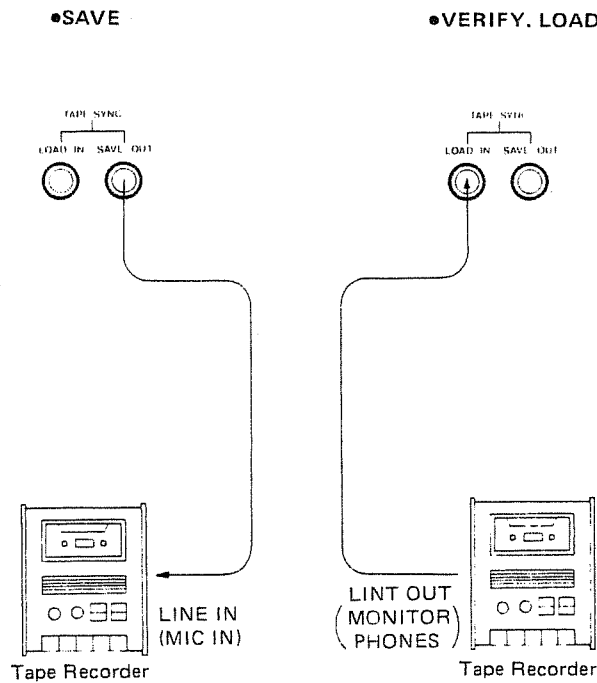

[Save]

- * If your tape recorder has MIC Input Line, use it.

[Load, Verify]

- * If it is possible, use the tape recorder featuring External Speaker or Headphone Jack rather than Line In Jack.

Level Test

Unlike any past device, the MSQ-700 features the Level Test function that enables you to find out appropriate level of your tape recorder in your first saving, therefore later verifying or loading procedure does not any longer require level experiment of the tape recorder. You only need to remember the level setting of this first saving.

► Operation

- ① Set the Mode Switch to the Tape position.

- ② Set the tape recorder to the recording mode.

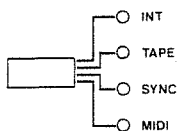

- ③ While holding the Clock Source Selector Key, press the Save Key in the Edit/Tape Mode Section.

Now test pattern will be recorded into the tape recorder. Wait for about 3 minutes.



- ④ Press the Reset Key.

- ⑤ Rewind the tape.

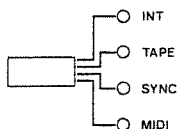

- ⑥ While holding the Clock Source Selector Key down, press the Load Key in the Edit/Tape Mode Section.

- ⑦ Set the tape recorder to playback mode and adjust its volume control.

- ⑧ Then find out the appropriate level.

* The best level can be easily seen by in the Display, that is, when a dot in the indication is moving from left to right. What you should do here is to find out the highest and lowest level between which the good indication with the moving dot is available. The middle of this range is the appropriate level of your tape recorder, so remember this for later verifying, or loading.

If is shown in the Display by pressing the Verify Key while holding the Clock Source Selector Key, hit the Reset Key.

Save

Putting a File Number to each data in saving will make later loading procedure considerably easier and quicker. 1 to 8 are available for the File Numbers.

► Operation

● Saving the Entire Data



- ① Press the Reset Key.

FILE



- ② If you wish to put a File Number, press one of the Track Keys 1 to 8. (The Track Keys here work as Number Keys.)

- 1

- ③ Set the tape recorder to the Recording mode.



- ④ Press the Save Key in the Edit/Tape Mode Section.

S - 1

The green indicators above the Tracks will light up, but those of the empty Tracks will not light up. So, you can tell which Tracks are going to be saved. The red indicator under the Track currently being saved will light up.

- ⑤ In a few minutes, saving will be completed.

End

● Saving a Track or Tracks you select



- ① Press the Reset Key.

FILE



- ② If you wish to put a File Number, press one of the Track Keys 1 to 8. Here, the Track Keys work as Number Keys.

- 2

(File Number 2)

- ③ Set the tape recorder to recording mode.

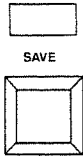

- ④ While holding the Save Key in the Edit/Tape Mode Section, press a relevant Track Key one after another to select the Tracks to be saved.

The green indicators above the keys initially light up. The red indicator under the Track currently being saved will light up.

- ⑤ Saving will be completed in a few minutes.

Verify

Please be sure to verify the saved data immediately after saving. Verify procedure is exactly the same as the saving procedure, except that you should press the Verify Key instead of the Save Key. In other words, you need to assign the same File Number as the saving (if you have put any in saving), and the same Track number(s) if you have saved a Track or Tracks you have selected.

► Operation

● Verifying the Entire Data



- ① If you have put a File Number in saving, assign the same number by pressing a Track Key.



- ② Press the Verify Key in the Edit/Tape Mode Section.

The green indicators above the relevant Track Keys light up. The red indicator under the Track Key currently being verified will light up one after another.

- ③ Set the tape recorder to playback mode.

- ④ Verifying will be completed in a few minutes.

- * If there is any error, **Err.** will be shown in the Display Window.

● Verifying the selected Tracks



① If you have put a File Number in saving, assign the same number with a Track Key.

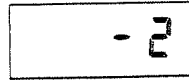

② While holding the Verify Key in the Edit/Tape Mode Section down, press the same Track Keys you have selected in saving procedure. (Here, the Track Keys are alternately turned on and off when pressed.)

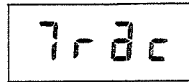

③ Set the tape recorder to playback mode.



④ If you have finished assigning all the relevant Tracks, release the Verify Key.

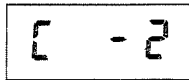

⑤ Verifying will be completed in a few minutes.

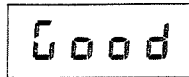

* If there is any error, **Err** will be shown in the Display Window.

* If you have assigned a File Number, the Display shows **CP-*** until the assigned data is found. Then **CF-*** is shown in the Display. If you have not assigned a File Number **C-O** is shown until the first file is found. Then **CF-*** is shown and verify will start.

If error is indicated

Rewind the tape and repeat verify procedure taking care of the following points.

- Be sure to rewind the tape thoroughly.
- Adjust the playback level of the tape recorder. (The appropriate level varies depending on the type of the tape recorder.)
- If the tape recorder features tone control, adjust it.
- Make sure that the connections are all made correctly and securely.
- Some tape recorders do not allow proper operation when both Save and Load connections are made at the same time. In such a case, make only the relevant connection.
- If your tape recorder has two kinds of In/Out Jacks (i.e. MIC/LINE In, EAR/LINE Out, etc), try using different ones this time.

If it still ends up with the same result

If error is indicated again and again how many times you try.

- Replace with a new tape (the one shorter than C-60).
- Clean and demagnetize the head of the tape recorder.

If error is still indicated, use different tape recorder and repeat saving procedure.

Load

► Operation

Set the Mode Switch to the Tape position.



- ① If you are loading data with a File Number, assign it by pressing the appropriate Track Key. (The Track Key serves as Number Keys here.)



- * If you do not assign any File Number, the data firstly found will be loaded.



- ② Press the Load Key in the Edit/Tape Mode Section, and loading will start replacing any existing data in the MSQ-700.

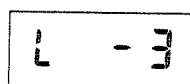

The red indicator under the Track currently loaded will blink, and it remains lighted when loading is completed.

- ③ Set the tape recorder to playback mode.

- ④ Loading will be completed in a few minutes.

- * If there is any error, Err will be shown in the Display.

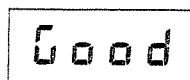

The red indicator under the relevant Track will remain blinking.

- There is another way of loading which is to automatically load into empty Tracks in the MSQ-700.

► Operation



- ① If you are loading data with a File Number, assign it by pressing the appropriate Track Key. (The Track Keys serve as Number Keys here.)

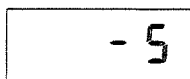

- * If you do not assign any File Number, the data firstly found will be loaded.

- ② Set the tape recorder to playback mode.



LOAD



③ While holding the Load Key in the Edit/Tape Mode Section, press the Overdub Key.



Then the data saved on the tape will be loaded into the empty Tracks without affecting the Tracks with data in it.

④ Loading will be completed in a few minutes.

* If there is any error, **Err** will be shown in the Display.

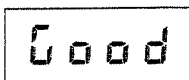

If empty Tracks are short for the loading data, **tr. FL** will be shown. When there is no memory capacity left, **FULL** will be shown.

If error is indicated

Rewind the tape and repeat load procedure taking care of the following points.

- a) Be sure to rewind the tape thoroughly.
- b) Adjust the playback level of the tape recorder. (The appropriate level varies depending on the type of the tape recorder.)
Try using the same tape recorder you have used in saving, if possible.
- c) Make sure that the connections are all made correctly.

■ **Appropriate Tape to be used**

* If you have assigned a File Number, **LP-*** will be shown until the assigned File Number is found. Then the Display responds with **LF-***. If you have not assigned any File Number, the data firstly found will be loaded, and the Display responds with **LF□**.

■ **Preserving the Data Tape**

Please do not keep the data recorded tape in extreme heat or humidity or near a strongly magnetic unit such as speaker or an amplifier. Also, be sure that the tape is completely rewinded.

Sync In/Out Function

The MSQ-700 can be perfectly synchronized with any unit featuring the DIN Sync.

● Sync In Jack

Connect the Jack to the Sync Out of the external unit, then turn the MSQ-700 to the Sync mode with the Clock Source Selector Key. The MSQ-700 works as a slave device which is controlled by the external signal. Therefore, controls for tempo, start/stop function, etc. are done by the external unit.

● Sync Out Jack

Connect this Jack to the Sync In Jack of the external device.

* The signal selected with the Clock Source Selector Key will control the tempo and start/stop function. If the INT is selected, the MSQ-700 will serve as a master device controlling the device connected to the Sync Out.

* As featured with this function, the MSQ-700 works as a Clock Interface among the devices featuring Tape Sync, DIN Sync or MIDI.

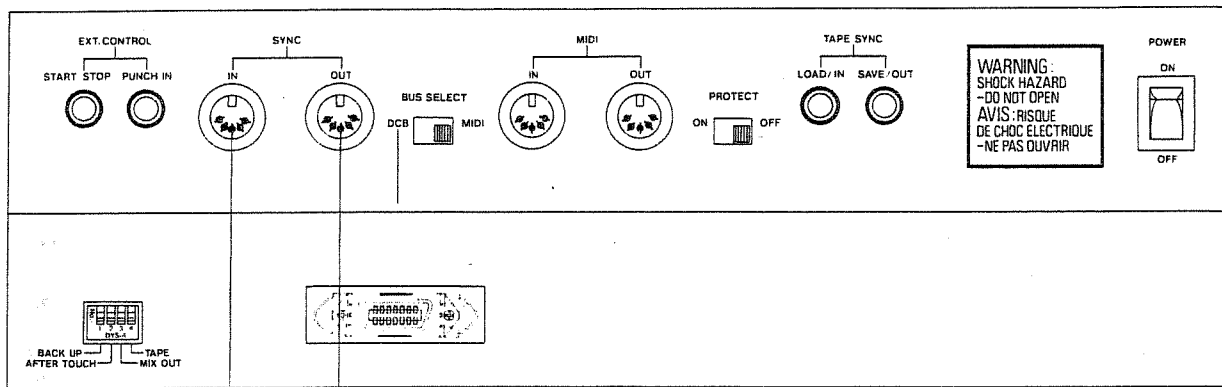

* If the MSQ-700 is used as a slave unit and if you stop it and continue to play, the units may not synchronize properly. If so, use the MSQ-700 as a master and the other device as a slave. Also, note that the Continue Play function is available only when the MSQ-700 is synchronizing with the MC-4 or TR-909, i.e. the data will start from the beginning otherwise.

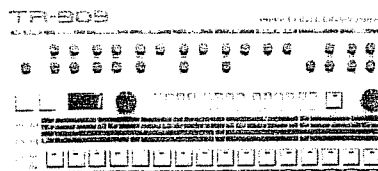
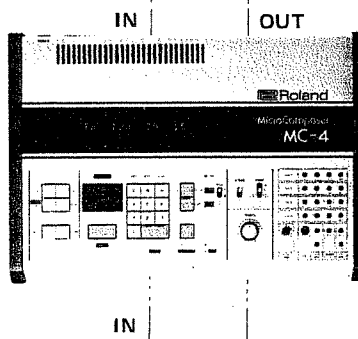
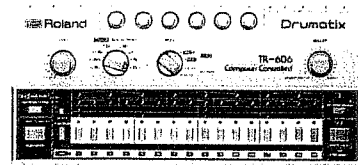

Other Useful Functions

Available Note

* If you set the Display mode to Avail Note, the Display Window tells you how many more notes can be loaded into the MSQ-700's memory. Moreover, if you press the Track Key at this stage, the Display shows how many notes that Track has used so far. If no memory is used at all, the maximum memory capacity 6500 is shown. Naturally, each Track has not used any memory, so "0" is shown by pressing any Track Key.

The following may seem strange to you, but there is nothing to worry about it, as it is merely caused by computer processing restriction.

- * The Display of the Available Notes can be seen in loading or playing mode, but the memory consumption of the Track is displayed only when the unit is not running.
- * What is shown in the Display does not represent the absolute number of the notes available (or consumed). So, do not rely on the number as a precise description, but use it to roughly grasp memory consumption.
- * The Display of each Track memory consumption starts from 48.
- * The Display of Available Note changes when the unit is turned from Loading to Playing mode.
- * The total number of all the Track memory consumption does not make 6500.

Changing MIDI Channel

► Operation

Press the Display Selector Key until the Status Indicator lights up.

To back the Channel number, press the Back Key while holding the MIDI Channel Key.

To forward the Channel number, press the Forward Key while holding the MIDI Channel Key.

* Thus the MSQ-700 allows you to load the data of the MIDI Channel you select out of several kinds of information sent from the external units.

MIDI (Musical Instrument Digital Interface) is international standard that enables communication of units by digital signal.

Refer to enclosed "What's the MIDI".

DCB is an interface system that converts CV/Gate signal into digital signal.

Specifications

MSQ-700

- Maximum Memory Capacity
Approx. 6500 notes (with 8tracks in all)
- Mode
Mode Switch (CHAIN, NORMAL, TAPE).
Memory Protect Indicator
- Clock
Clock Source Selector Key and Indicators
(INT, TAPE, SYNC, MIDI)
- DISPLAY
Display Selector Key and Indicators (MEASURE/
CHAIN, AVAIL NOTE, TEMPO, STATUS)
- Track
Track Keys (1 to 8),
Play Track Indicator (1 to 8)
Load Track Indicator (1 to 8)
- Load
Load Mode Switch (REAL, TIME/STEP)
Beat per Measure Selector Switch and Indicators
(FREE, 1 to 6, and 8),
Resolution Selector Switch and Indicators (1/32,
1/24, 1/16, 1/12, 1/8, 1/6, 1/4, 1/2)
Overdub Key and Indicator
Tie Key and Rest Key with Indicators
Load Key and Indicator
MIDI Channel Selector Key
- Play
Multi Track Key and Indicator
Play Key and Indicator
Repeat Switch (ON/OFF)
- Step and Stop
Reset Key, Back Key, Forward Key,
Stop Continue Play Key and Indicator
- Tempo
Tempo Knob ( = 35 to 260)
Beat Indicator,
Metronome Switch (OFF, LOAD/PLAY, ON)
- Edit
Erase Key, Merge Key
Time Correct Key
- Tape Memory (3200 baud)
Save Key, Verify Key, Load Key
- Rear Pannel
External Control (START/STOP, PUNCH IN),
Sync (DIN Terminal IN/OUT)
MIDI In/Out Jacks,
Bus Selector Switch (DCB/MIDI)
Tape Sync (LOAD/IN, SAVE/OUT),
DCB Connector
Memory Protect Switch (ON/OFF)
- Sub Switch
 - 1 BACK UP (ON/OFF)
 - 2 AFTER TOUCH (ON/OFF)
 - 3 MIX OUT (ON/OFF)
 - 4 TAPE (HIFI/NORMAL)
- Dimensions
346(W) x 328(D) x 108(H) mm
13-5/8 x 12-15/16 x 4-1/4 in
- Weight
5kg/11-1/8 lbs.
- Power Consumption
14 W
- Accessories
DCB Cable (3m) x 1, 5 P DIN Cable (2.5m) x 2

Option

DP-2

* Specifications are subject to change without notice.

 Roland®

10193

UPC 10193



10901

 Roland